



HEAD OFFICE /
No.67, Ln, 209, Sec.2, Sanfong Rd., Fongyuan Dist.,
Taichung City 42054, Taiwan (R.O.C.)

CTSP /
No.53, Houke S. Rd., Houli Dist.Taichung City
42152, Taiwan
TEL / +886-4-25577650
FAX / +886-4-25577630
E-mail / km@kaoming.com.tw
www.kaoming.com



KM website



Cat.38 1809(E)x2000A



KMIC-DV

KAO MING Scientific and Technological Giant of the Most Humane Intention

Kao Ming Machinery Industrial Co., Ltd.

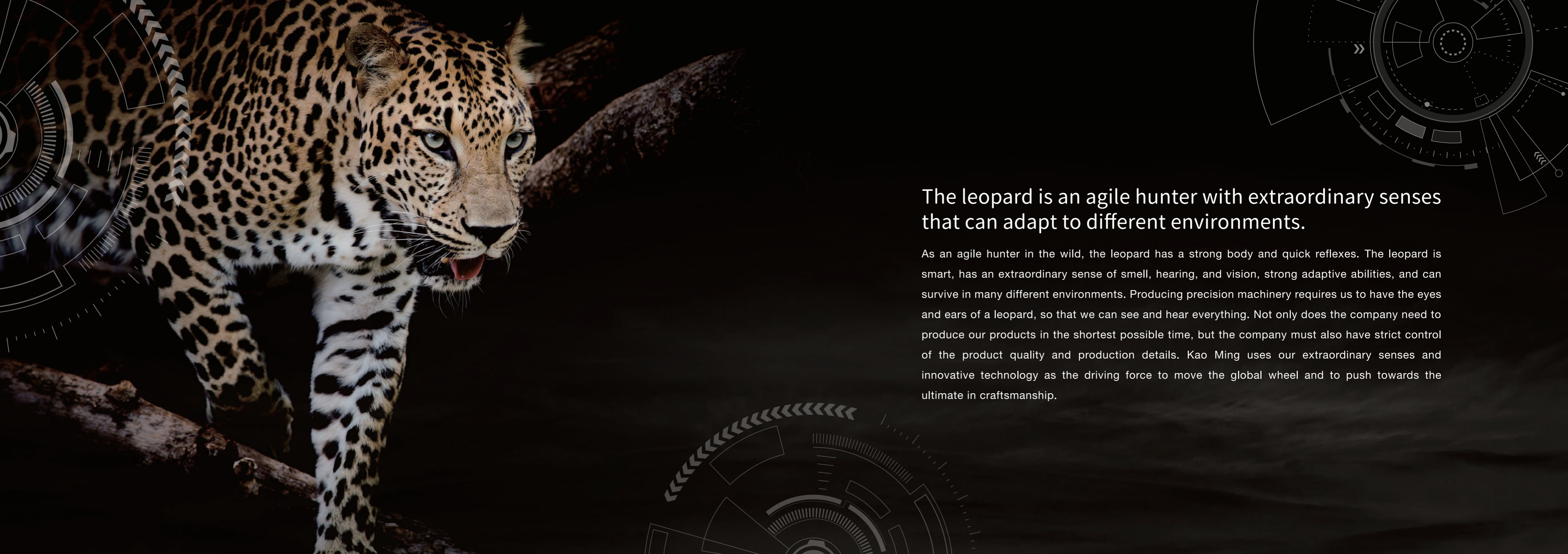

The leopard is an agile hunter with extraordinary senses that can adapt to different environments.

As an agile hunter in the wild, the leopard has a strong body and quick reflexes. The leopard is smart, has an extraordinary sense of smell, hearing, and vision, strong adaptive abilities, and can survive in many different environments. Producing precision machinery requires us to have the eyes and ears of a leopard, so that we can see and hear everything. Not only does the company need to produce our products in the shortest possible time, but the company must also have strict control of the product quality and production details. Kao Ming uses our extraordinary senses and innovative technology as the driving force to move the global wheel and to push towards the ultimate in craftsmanship.

KMC-DV SERIES

MAIN CHARACTERISTICS

High-speed vertical double-column machining center

1. The 15000 rpm high-speed spindle satisfies the high-speed and high precision processing requirements of molds and general precision parts.
2. This machine has a gantry structure with the Y axis independently located on the vertical column's arch-bridge. The X axis is independently located on bed so that overlapping load and overhang can be prevented.
3. Three-axis roller-type linear motion guide: the roller post and guide is of the linear contact type. When the rolling element takes on a heavy load, the element only exhibits trace amounts of elastic deformation. Thus, this type of guide has a long life, high precision, and can bear heavy loads.
4. Utilizes high precision, high stability, high rigidity, and high efficiency precision direct drive type spindle. An optional low vibration, low inertia, dynamic rotation high precision internal spindle can be selected. Different spindles can be matched to different cutting requirements.
5. The front and rear beds of the three axes and the main fixing surface have undergone scarping processing to ensure the machine has a long service life.
6. Telescopic interlocking sliding door. This door allows the operator to be closer to the spindle (375 mm) when opened. This user-friendly design makes it convenient for the operator to load and unload tools and work pieces.
7. The cutting fluid that passes the spindle's center device (special attachment) can eliminate the iron filing and heat problem in high speed cutting, and ensure the stability and precision of the work piece.
8. The machine can be matched with a data server, AICC II, or high-speed processor according to customer need to realize high-speed, high precision processing.



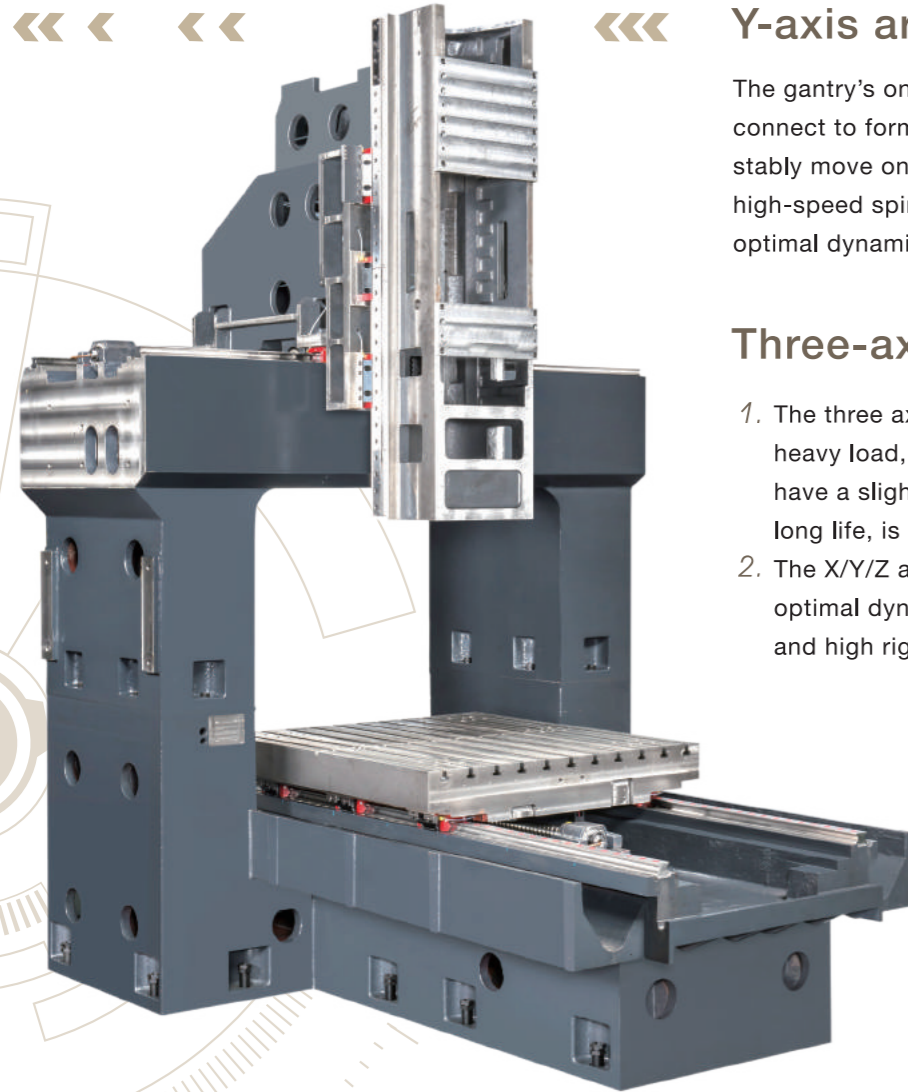

Y-axis arch type structure

The gantry's one piece double-column structural design and the bed's one-piece design perfectly connect to form a highly rigid main arch structure. The reduced weight head saddle can rapidly and stably move on the horizontal Y axis' two roller linear motion guides. This can ensure that the high-speed spindle can rapidly, rigidly, precisely, and stably feed the three axes, as well as ensure the optimal dynamic rigidity.

Three-axis roller linear motion guide

1. The three axes utilize a roller linear motion guide. When under heavy load, the roller will not produce differential slip, and will only have a slight elastic deformation. Thus, the motion guide has a long life, is highly precise, and can bear heavy weight.
2. The X/Y/Z axes have a 6/4/6 slide block design that ensures the optimal dynamic rigidity so that the machine meets the high-speed and high rigidity requirements.
3. Linear guide is less likely to produce stick slip phenomenon, which makes the machine more sensitive when inching and using the minimum feed. This can increase the mold's cutting geometric precision when changing direction or reversing.

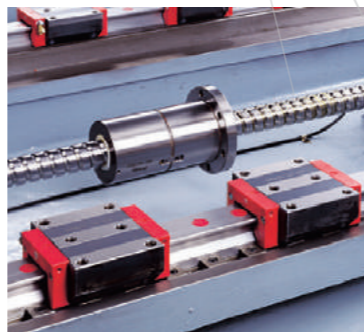

Dual blowing cooling system

Dual blowing cooling system for the hollow ball screw and bearing housing can effectively control thermal displacement and ensure position precision.



Scarping technology

To ensure the machine's precision reaches the highest standard, scarping technology is an important key. The precision of the structures, including vertical, horizontal, and flat geometric precision relies on experienced professional scarping technicians. The scarping is carved individually and each unit area's scarping connection points reach the highest standard in precision machinery. The scarping work is tested with precision instruments so that the machine's dynamic precision is adjusted to the optimal setting.

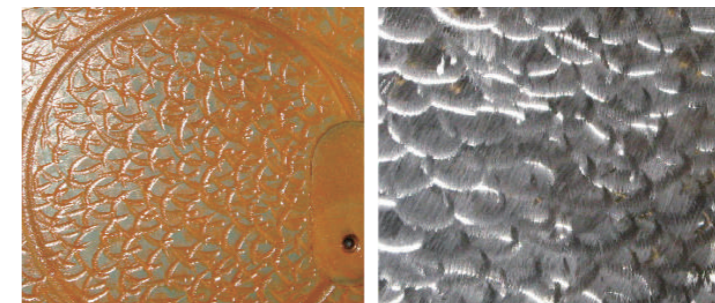
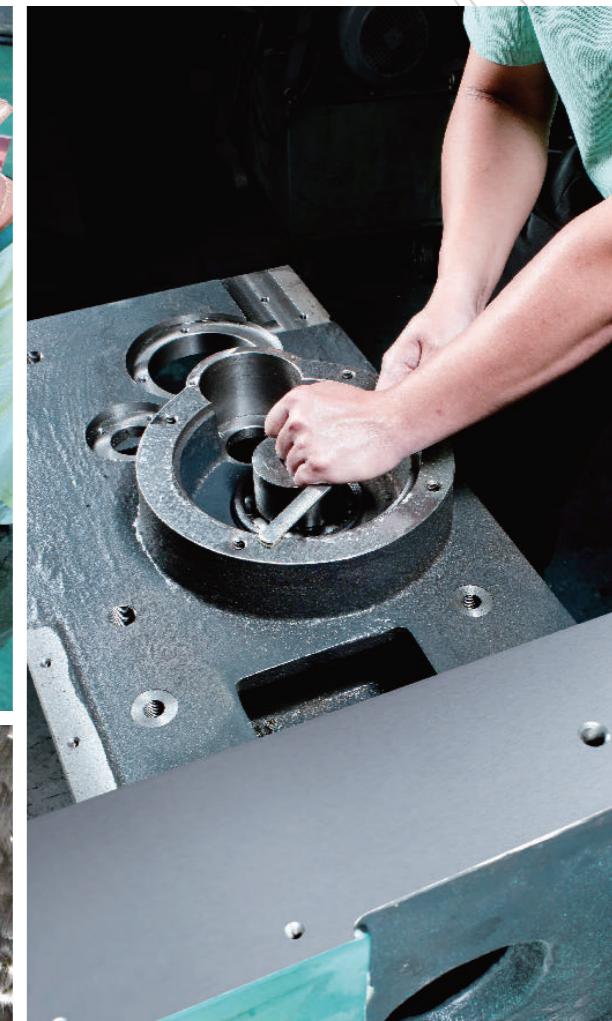

HIGH-SPEED SPINDLE

Direct-drive Spindle >>>>

Compared to traditional belt or gear type transmissions, direct drive spindle has higher precision, stability, rigidity, and efficiency, and can satisfy the high-speed and high precision processing need of molds and general confidential parts. In addition, the simple structure is convenient to assemble and maintain, and can effectively lower the customer's purchase cost and maintenance cost. This increases the company's overall competitiveness and is the best choice for high-speed high precision cutting mold. The direct drive spindle uses high precision ceramic ball bearings that have been greased and lubricated (standard equipment).

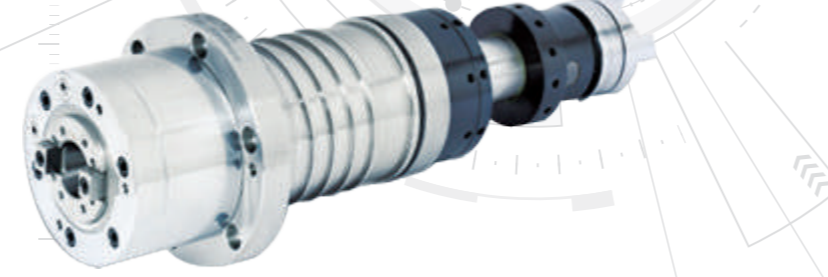

Built-in Spindle >>>>

1. The 12,000 rpm - 22/25 kw (33 HP) wide area built-in spindle motor uses high precision roller bearing as the front and back support. Oil-air lubrication is added to effectively decrease spindle thermal displacement produced by high-speed operation. The spindle cooling oil can also remove heat produced by the spindle and motor operation, thereby improving the cutting mold's processing precision and stability. To ensure spindle bearing, air dryer must be used. Follow-up precision air filter must also be configured.

2. The 15,000 rpm - 11/18.5 kw (25HP) built-in spindle uses high precision ceramic ball bearing. Grease lubrication is also used (standard equipment). Special oil-air lubrication can also be selected for high-speed precision processing.

3. The built-in spindle motor effectively improves dynamic rotation precision and improves the surface roughness and precision of the

work piece. This is the design used for the high-speed spindle.



Advantages

- Easy to achieve ultra-high speed
- Balance calibration to within G1. Low vibration
- Small size. High spindle power
- Easy to modularize
- Low noise, small thermal displacement
- Dynamic rotation precision

Advantages

- Simple structure
- Fast machine assembly
- High precision, low vibration
- Easy to achieve high-speed
- Excellent dynamic rotation precision

α iT15/15000
15/18.5/22KW(20/25/30HP)

15000RPM (ISO 40)

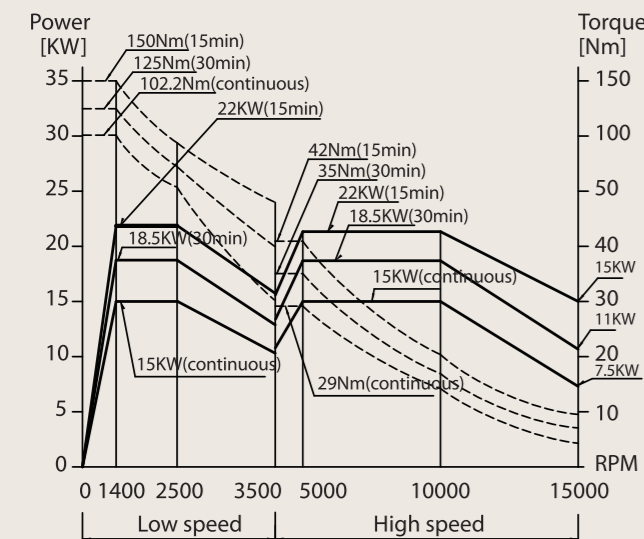

α iT22/12000+Extra Amp.
22/26/30KW(30/35/40HP)

12000RPM (ISO 40)

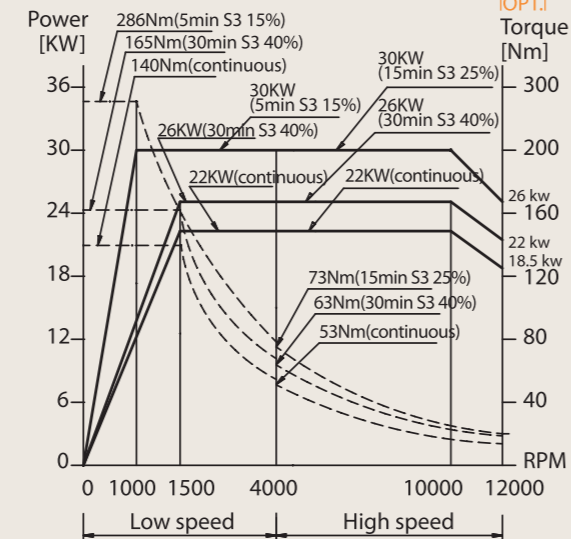

Bil 112S-11/18.5KW(25HP)
(Built-in)

15000RPM (ISO 40)

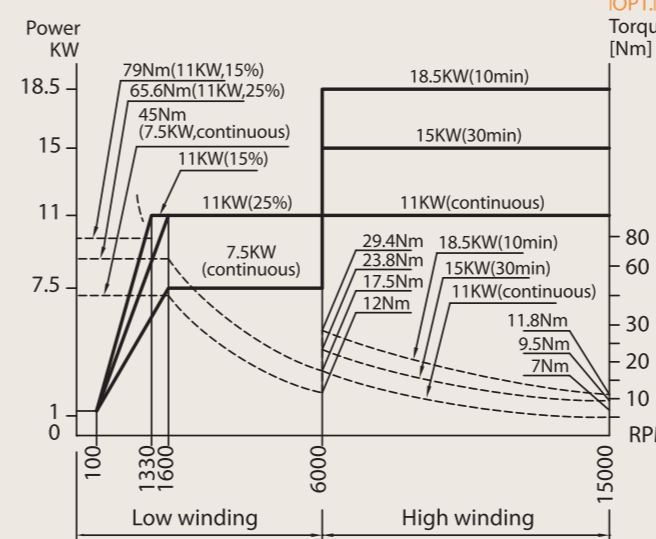

Bil 132L-22/25KW(33HP)
(Built-in)

12000RPM (ISO 40)

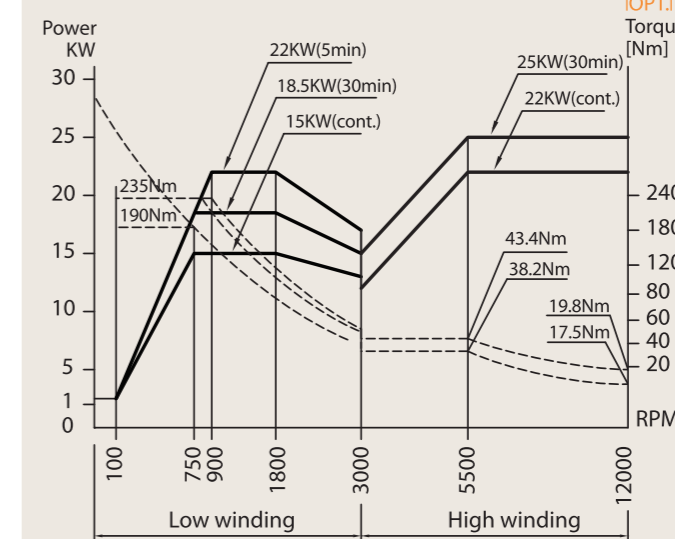

HIGH-SPEED MOLD PROCESSING >>>> >> >>

The DV system is most suitable for high speed automobile mold, plastic mold, and die casting processing. Other precision parts, such as parts for aerospace and machine tools, are also within the application scope of this product. Configured with data server and AICC look ahead function and the system can be used for mold high-speed high precision processing.

Cutting example

*Direct drive spindle 12000 rpm

	Work piece material	Tool (mm)	Cutting width (mm)	Cutting depth(mm)	Spindle rotation speed (rpm)	Feed (mm/min)	Cutting quantity (cc/min)
Face milling	S45C	Face milling blade Ø80	70	4.5	980	1600	504

*Built-in spindle 12000rpm

	Work piece material	Tool (mm)	Cutting width (mm)	Cutting depth(mm)	Spindle rotation speed (rpm)	Feed (mm/min)	Cutting quantity (cc/min)
Face milling	S45C	Face milling blade Ø80	80	5	980	1700	595



Coolant through spindle system (special option)

Provide a 600L large capacity water tank. The optional, coolant through the spindle feature utilizes a complete pump/filtration system, rather than a single auxiliary pump as commonly used by our competition. This system is equipped with a large 600L capacity reservoir, high pressure pump, and duplex filter unit, with a choice of various output pressures.

> Filing liquid passing the spindle's central water tank



	Medium pressure	High pressure	
Pressure	20bar(284psi)	40bar(568psi)	70bar(994psi)
Quantity	30L/min (7.92gal/min)	30L/min (7.92gal/min)	30L/min (7.92gal/min)

Stable cam type ATC

32 tool chain-type magazine paired with rapid cam type tool change mechanism. The tool change time is only 1.8 seconds (tool to tool).

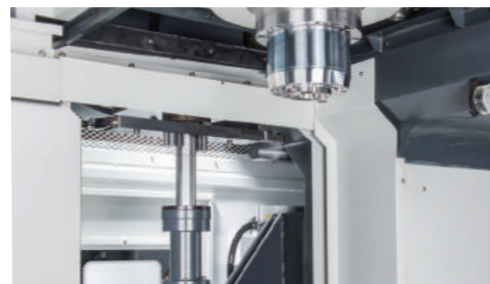

Machine standard attachment



➤ Spindle cooler



➤ Electricity control box air conditioning cooling system

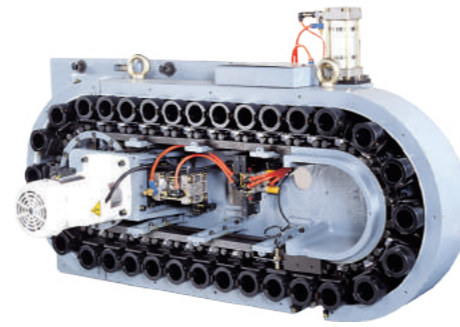

➤ Chain-type tool magazine

Special attachments



➤ Automatic tool length measurement system



➤ Automatic probe work piece centering system

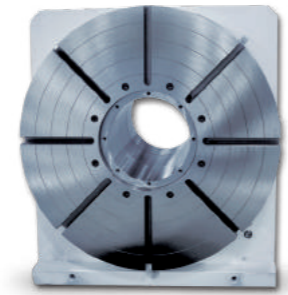





➤ NC turning work platform

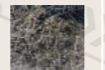
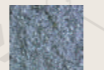

➤ Air drier (built-in spindle use)

Link-type chip conveyor (Optional)

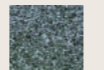

					
	●	●			
			●	●	●

MACHINE SPECIFICATION TABLE

Unit: mm

Model	Specifications	KMC-1200DV	KMC-1800DV	KMC-2400DV
Travel	Distance between machine columns	1300 (51.2")	1300(51.2")	1300(51.2")
	X axis (work platform forward and reverse movement)	1340 (52.7")	1940(76.4")	2540(100")
	Y axis (spindle head left and right movement)	1200 (47.2")	1200(47.2")	1200(47.2")
	Z axis (spindle head up and down movement)	700 (27.6")	700(27.6")	700(27.6")
	The distance from the spindle's front end to the work platform	150~850 (6"~33.5")	150~850 (6"~33.5")	150~850 (6"~33.5")
Work platform	Work platform area	1200 x 1120 (47.2" x 44")	1800 x 1120 (70.86" x 44")	2400 x 1120 (94.4" x 44")
	Maximum load weight	2200 kgs (4840 lbs)	3500 kgs (7700 lbs)	4500 kgs (9900 lbs)
	T-slot	18 x 11 x 100 (0.71" x 0.43" x 3.94")		
Spindle	Spindle rotation speed	100~15000 rpm		
	Spindle speed change speed	2-Step with electric changeover		
	Spindle taper	7 / 24 (ISO 40)		
	Spindle diameter	Ø70 (Ø2.76")		
	Spindle motor (continuous/30 minutes)	15/18.5 kw (20 / 25HP)		
	Spindle maximum torque	150 Nm		
Feed rate	Fast feed speed (X,Y,Z-m/min)	X-40,Y-40,Z-24	X-30,Y-40,Z-24	X-30,Y-40,Z-24
	Cutting feed	1-15000 min/min (0.04~590ipm)		
Automatic Tool Changer	Shank	BT40 (*HSK-63A, *BBT 40)		
	Tightening bolt	MASP40T-1 (45°)		
	Magazine capacity	32 tools (*40)		
	Maximum tool diameter	Ø75(Ø3")/Ø150(Ø6")(without adjacent tools)		
	Maximum tool length	300 (11.8")		
	Maximum tool weight	8 Kg (17.6 lbs)		
	Tool change time (tool to tool)	1.8 Sec		
Electrical power and air pressure	Connecting electrical power	45 KVA		
	Air pressure	5-7 Kg/cm ² (70~80 psi) 500 L/min (132gal/min)		
Machine size standard	Machine height	3495 (138")	3495 (138")	3495 (138")
	Floor area (length x width)	5032x4275 (198.1"x168.3")	6233x4275 (245.4"x168.3")	7433x4275 (292.6"x168.3")
	Machine net weight	12500 kgs (27500 lbs)	14500 kgs (31900 lbs)	17500 kgs (38500 lbs)
Precision	Position precision	JIS 6338	±0.005/full travel	
		VD13441	P 0.020	
	Reproducibility	JIS 6338	±0.002/full travel	
		VD13441	Ps 0.015	
CNC controller	FANUC Oi (31MB) series, *HEIDENHAIN, *SIEMENS			

*Special designation: This company reserves the right to change the aforementioned specifications at any time.

Standard Accessories

- | | |
|---|--|
| 1. 12000 rpm high-speed spindle (Direct-drive) | 9. Fully enclosed splash guard |
| 2. High-speed spindle grease lubricating system | 10. Work light |
| 3. High-speed spindle cooling system | 11. Warning light |
| 4. 32 tool chain-type magazine | 12. Work completion warning light |
| 5. Spiral type filing conveyor | 13. Automatic power cutoff function |
| 6. Central collection type automatic lubrication system | 14. Rigid tapping |
| 7. Cooling nozzle device | 15. Transformer (other than 220V power) |
| 8. Automatic air blowing device | 16. Electricity control box cooling system |

Optional Accessories

- | | |
|---|--|
| 1. 15000 rpm high-speed spindle (direct drive) | 11. Extra-large water tank |
| 2. 24000 rpm high-speed spindle (built-in) | 12. Water-oil separator |
| 3. NC rotary work platform CAT40, DIN40, ISO40, | 13. Gas passes through the spindle center (M command air/water switching) |
| 4. HSK-63A, and BBT shank | 14. Kao Ming temperature increase thermal displacement compensation system |
| 5. Oil hole drill interface | 15. Oil-gas lubrication system |
| 6. Cutting fluid passes the center | 16. Cutting fluid paper passes the filtering system |
| 7. Automatic tool length measurement | 17. Oil vapor cooling installation |
| 8. Automatic probe work piece centering system | 18. Air dryer (built-in spindle use) |
| 9. Digital ruler feedback position detection system | |
| 10.Link-type chip conveyor | |

FLOOR AREA, WORK PLATFORM SIZE, AND PROCESSING TRAVEL

Floor size

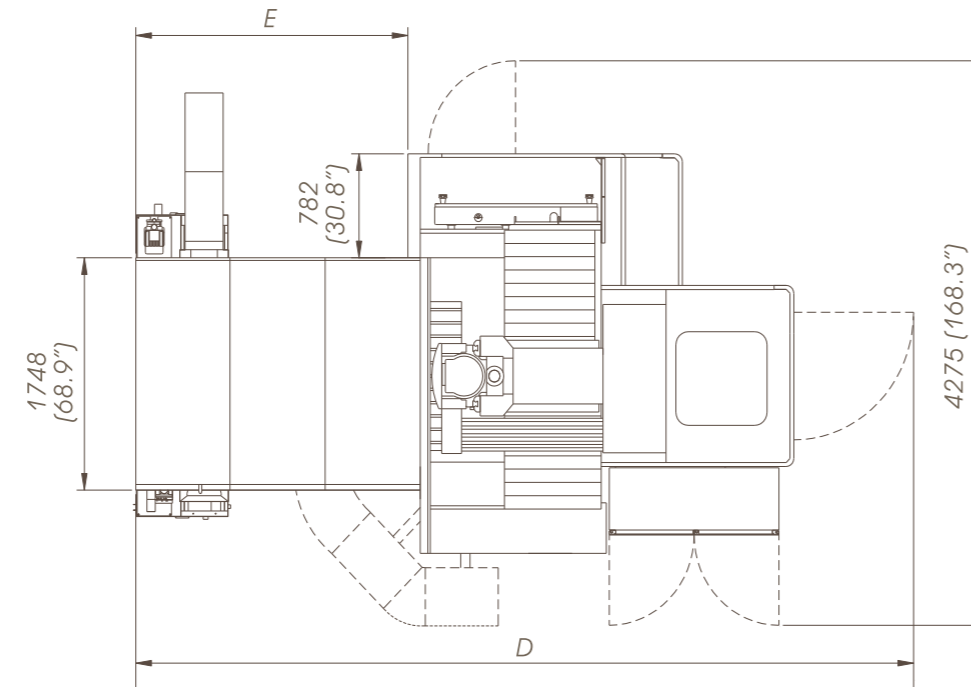
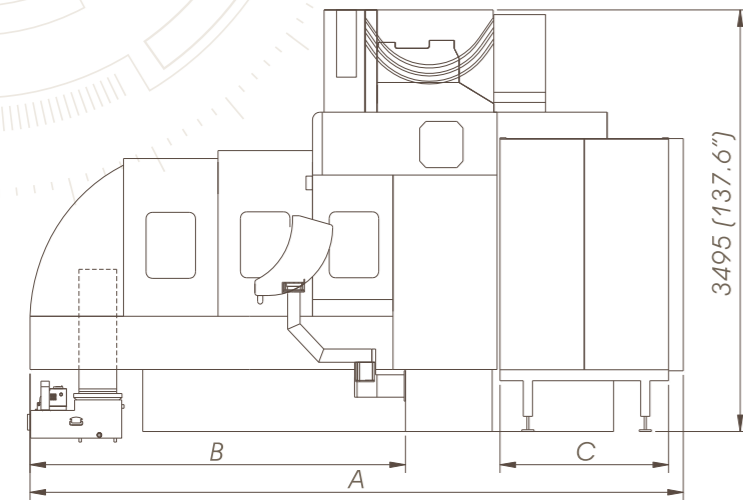

Processing travel

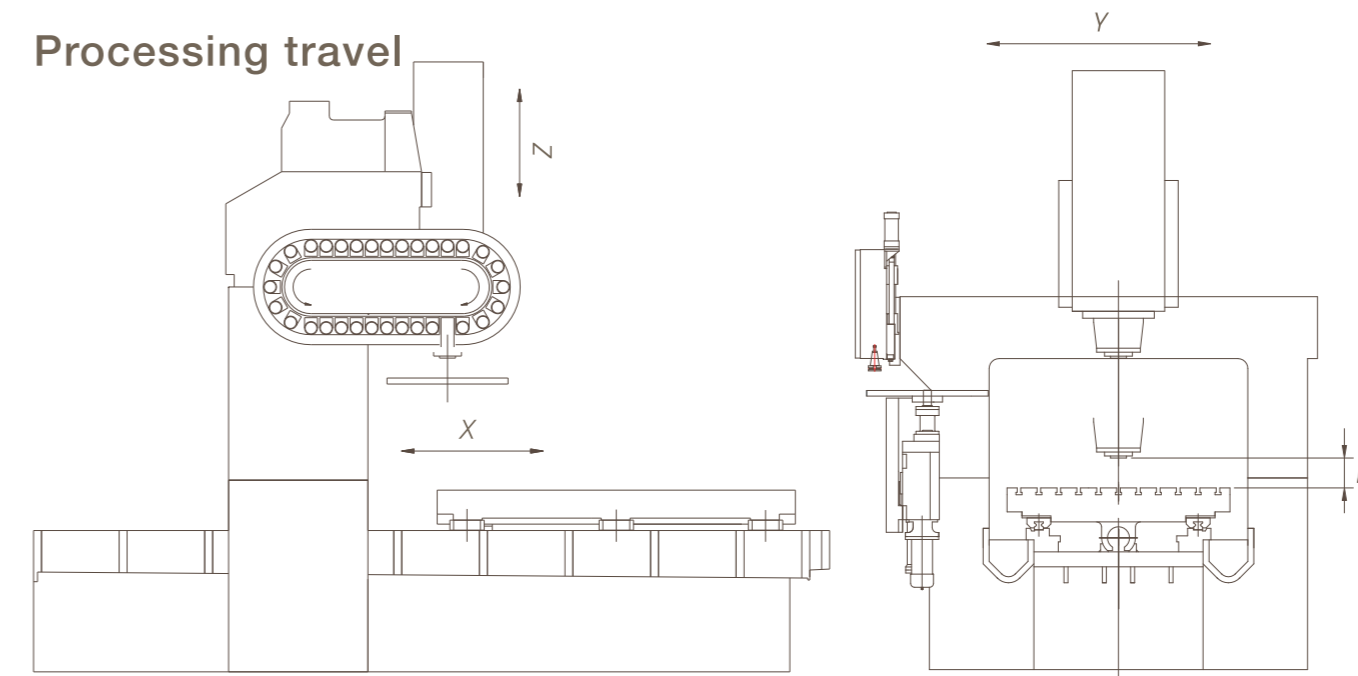

Work platform size

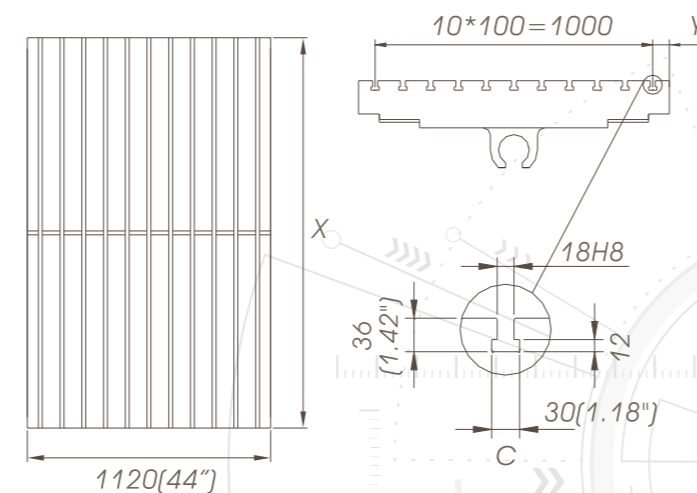

Unit: mm (inch)

Size comparison	Machine model	1200DV	1800DV	2400DV
Floor size	A	4914(193")	5273(208")	6473(255")
	B	2430(95.6")	3030(119")	3630(143")
	C	1360(53.5")	1360(53.5")	1360(53.5")
	D	5033(198")	6233(245")	7433(293")
	E	1620(63.7")	2220(87.4")	2820(111")
Work platform	X	1200(47.2")	1800(70.86")	2400(94.4")
	Y	60(2.36")		

Unit: mm (inch)

Items	1200DV	1800DV	2400DV
X-axis table travel (X)	1340(52.7")	1940(76.4")	2540(100")
Y-axis spindle head travel (Y)	1200(47.2")	1200(47.2")	1200(47.2")
Z-axis spindle head travel (Z)	700(27.6")	700(27.6")	700(27.6")
Distance from spindle nose to table top (D)	150~850 (6"-33.5")	150~850 (6"-33.5")	150~850 (6"-33.5")
Load capacity	2200kg(4840 lbs)	3500kg(7700 lbs)	4500kg(9900 lbs)